

INSTRUCTION MANUAL

PHILCO JUNIOR SCOPE, MODEL 7019

FOR THE RADIO SERVICEMAN—AMATEUR—EXPERIMENTER

FOR PORTABLE USE IN THE ELECTRONIC LABORATORY

The PHILCO JUNIOR SCOPE, Model 7019, is designed to provide a compact, portable, low-cost oscilloscope for the radio serviceman, the radio amateur and the experimenter—also for general portable use in the laboratory. The small size and light weight of the JUNIOR SCOPE make it extremely easy to move and to set up near the equipment to be tested. Two rubber-covered test leads, equipped with pin tips and alligator clips, are supplied with the JUNIOR SCOPE.

SPECIFICATIONS

Overall Dimensions: Height, 6 $\frac{3}{8}$ " ; depth, 10" ; width, 4".

Weight: 5 $\frac{3}{4}$ lbs.

Operating Voltage: 110-120 volts, 60 cycles, a.c.

Power Consumption: 23 watts (at 117 volts, 60 cycles).

Terminals: VERTICAL—two pin-jacks for vertical input voltage.

HOR/SYNC—two pin-jacks for horizontal input or synchronizing voltage.

Tube Complement: Vertical amplifier—6AU6.
Time-base oscillator and horizontal amplifier—6J6.
Rectifier—6X4.
Cathode-ray tube (2-inch screen)—2AP1-A.

OPERATING DATA

CHARACTERISTIC	WITH AMPLIFIERS (MAX. GAIN)	DIRECT CONNECTION TO DEFLECTING PLATES
Vertical deflection sensitivity	*1 v/inch, r.m.s.	*30 v/inch, r.m.s.
Horizontal deflection sensitivity	*1 v/inch, r.m.s.	*24 v/inch, r.m.s.
Fidelity	*-2 db from 20 cycles to 100 kc.	Depends upon external connections
Input resistance	.5 megohm	.5 megohm
Input shunt capacitance	36 mmf	36 mmf
Input series capacitance	.1 mf	.1 mf
Direction of deflection	Up for positive vertical input; left for positive horizontal input	Down for positive vertical input; right for positive horizontal input
Direction of sweep deflection	Left to right	Left to right
Sweep - frequency range		10 cycles to 50 kc

* Approximate values.

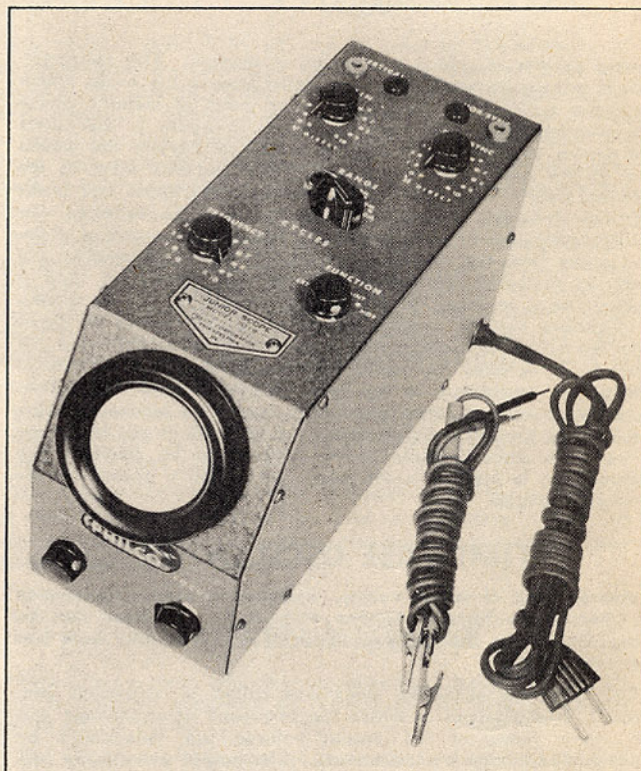

FUNCTIONAL ANALYSIS OF AN OSCILLOSCOPE

A cathode-ray oscilloscope is an instrument that provides instantaneously plotted curves for the visual observation of alternating-voltage wave forms or pulses having a definite recurrence rate. The oscilloscope contains a cathode-ray tube, power supply, amplifiers for the voltages to be observed, and suitable controls for causing the electron beam within the tube to trace curves on the circular "screen" at the end of the tube.

CATHODE-RAY TUBE

The cathode-ray tube, which is the heart of the oscilloscope, is an elongated, high-vacuum glass tube; one end contains the electron "gun", and the other end is enlarged to provide a circular viewing screen. A stream of electrons, directed from the electron gun, travels lengthwise through the tube, striking the specially-treated inner surface of the screen, which gives off a luminous glow at the point where the electron beam strikes.

DEFLECTING PLATES

Since the screen coating retains its glow for an instant after being subjected to this electron bombardment, a sudden movement of the electron beam in any direction causes a thin, luminous line, or "trace", to appear on the screen. Inasmuch as each electron is negatively charged, and the electron beam is of extremely light weight, the beam is easily diverted by any

SYNCHRONIZATION

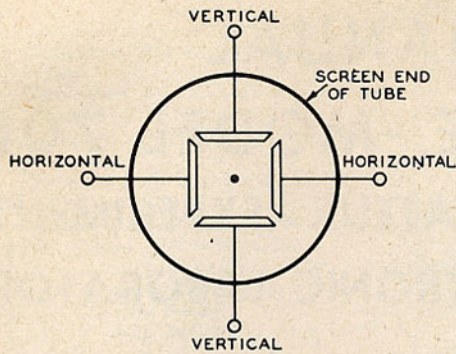

Figure 1.

nearby surface to which a potential is applied. This characteristic is utilized to bring about the deflections of the beam which trace the patterns on the screen. Two pairs of metallic plates are mounted within the tube, as shown in figure 1; the plates are drawn as they would appear if viewed through the screen end of the tube—the dot represents the endwise view of the electron beam. A voltage applied between the upper and lower (vertical) deflecting plates causes the beam to be deflected vertically either upward or downward (toward the positive plate, and away from the negative). If the voltage is alternating, the beam is deflected alternately upward and downward, and a vertical trace appears on the screen. Similarly, an alternating or recurrent voltage applied between the two plates at either side (horizontal deflecting plates) causes a horizontal trace. If alternating voltages are applied simultaneously to both sets of plates, the combining of the two voltages causes the screen pattern to assume a curve, or a set of curves, by means of which the frequency relationship between the voltages (if one frequency is equal to some multiple of the other) may be studied. The voltage that is applied to the horizontal plates is known as the "sweep" voltage.

TIME-BASE OSCILLATOR

Another form of sweep voltage, designed to permit observation of alternating-voltage variations with respect to time, can be generated by the time-base oscillator, which is usually built into the oscilloscope.

The time-base oscillator, sometimes called a "saw-tooth generator", uses a circuit in which the frequency of oscillations and the wave forms of the output voltage are determined by resistance-capacitance combinations. The output wave forms produced by this circuit are of saw-tooth shape, as shown in figure 2. When these voltages are applied to the horizontal deflecting plates, the variations in an alternating voltage at the vertical plates, with respect to time, may be observed on the screen. In order that the time element shall be accurate (that is, the time difference represented by the horizontal screen distance between two given points shall be the same as the time between any other two points separated by the same distance), the upward slope of the saw-tooth wave must be essentially linear.

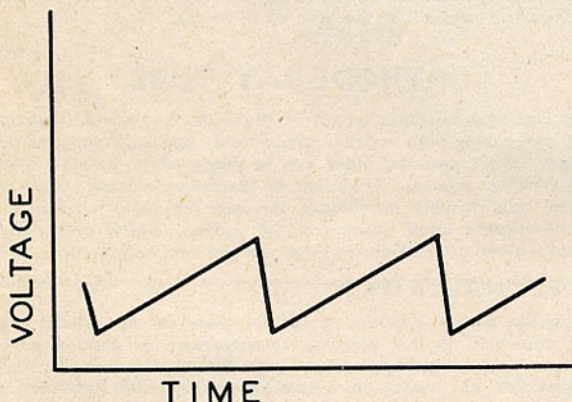

Figure 2.

When the frequency of the sweep voltage applied to the horizontal plates is adjusted, so as to become equal to some multiple of the frequency of the voltage at the vertical plates the pattern on the screen stands still; the two voltages are then said to be synchronized. Because of minute continuous changes in tube circuits, caused by variations in emission, heating of associated parts, etc., it would be very difficult to hold a screen pattern stationary unless some special provision were made to maintain the synchronization of the sweep voltage with the applied alternating voltage. Self-controlled synchronizing is attained by taking a voltage from the same source that controls the frequency of the vertical input voltage, and feeding this energy to the sweep-generator (time-base oscillator) circuit in such a manner as to control the starting time of each saw-tooth sweep. The synchronizing energy thus used is controlled in amplitude by the synchronizing, or "sync" control, the proper adjustment of which causes the sweep generator to "lock in" with the applied sync signals, thus holding the screen pattern stationary.

Another method of obtaining synchronization is to employ the vertical-input signal itself; a small amount of the amplified signal voltage is taken from the vertical-amplifier circuit and fed to the sweep generator.

CIRCUIT DESCRIPTION OF PHILCO JUNIOR SCOPE

Referring to the schematic diagram, figure 25, the first tube, type 6AU6, is used in the vertical-amplifier circuit. The input amplitude is controlled by the .5-meg potentiometer used as the GAIN control. When the control is turned to maximum counterclockwise position, switch S101 is thrown to the position opposite that shown in the diagram, applying the input signal directly to the vertical plates of the cathode-ray tube.

When the GAIN control is turned to any clockwise position, switch S101 connects the output circuit of the amplifier through condenser C104 to the vertical plates. The small air-core inductance coil, L100, functions as a shunt-peaking coil to improve the high-frequency response of the amplifier.

A small amount of the amplified voltage in the plate circuit appears across the 560-ohm resistor R104, which is connected to the INT terminal on the FUNCTION switch S103. This voltage is used for internal synchronization; thus, the small amount of energy required to synchronize the sweeps may, when desired, be taken from the amplified vertical-input voltage instead of an external source.

The cathode-ray tube, type 2AP1-A, is mounted so that its two-inch screen projects slightly from the front end of the housing. A potentiometer, R106, in the negative circuit of the power supply, provides an adjustable negative bias for the control grid of the tube; this potentiometer is the INTENSITY control, and is combined with the a-c power switch S100, which turns the scope power on and off. The first-anode (focusing-anode) voltage is taken from the variable arm of potentiometer R108, which forms a part of the voltage divider across the output of the power supply. This potentiometer is used as the FOCUS control. The second-anode voltage is taken from the positive output of the power supply.

The double-triode tube, type 6J6, is used as a time-base oscillator or an amplifier for horizontal input voltage, depending upon the position of the FUNCTION control, S103.

The time-base oscillator uses a multivibrator circuit incorporating both triode sections of the tube. The correct values of capacitance for each range are selected by the RANGE switch, S104. It will be noted that the unique switching arrangement uses certain condensers in more than one switch position, thus making six condensers perform the functions of ten. Gradual control of the sweep frequency is provided by the FREQUENCY control; this is a dual unit having one potentiometer in the control-grid circuit, and the other in the plate circuit. The GAIN/SYNC control consists of a .5-meg potentiometer, the variable arm of which is connected to one of the control grids (pin 6) of the 6J6 tube; by means of this control, the amplitude of the applied synchronizing voltage is adjusted until the time-base oscillator synchronizes with this voltage, or with a multiple of its frequency. The FUNCTION switch has four positions, three of which (EXT, LINE, and INT) are used to switch the GAIN/SYNC control circuit to the desired source of sync voltage; in the EXT position, an external sync voltage may be applied through the

HOR/SYNC input terminals, J102 and J103; in the LINE position, the sync voltage is taken from the line supplying the scope, by means of a connection to the filament winding on the power transformer; in the INT position, the sync voltage is taken from the amplified vertical-input signal itself, by means of a connection to the junction of the peaking coil, L100, and resistor R104, in the plate circuit of the vertical amplifier.

When the FUNCTION switch is thrown to HOR position, one section of the 6J6 tube is made inoperative by grounding the control-grid circuit; the other tube section then becomes an amplifier for the horizontal-input voltage. When the GAIN/SYNC control is turned on, switch S102 connects the horizontal plates of the cathode-ray tube, through condenser C106, to the plate circuit of the horizontal amplifier. When the GAIN/SYNC control is turned to its maximum counterclockwise position, switch S102 applies the input voltage at terminals J102 and J103 to the horizontal plates of the cathode-ray tube.

The power supply for the scope is furnished by transformer T100, a type 6X4 tube operating as a rectifier, and the two 8-mf electrolytic filter condensers, in addition to the voltage dividers previously mentioned.

SUMMARY OF CONTROLS AND THEIR FUNCTIONS

GAIN—potentiometer with two-way switch: clockwise rotation switches in the vertical amplifier, and controls the amplitude of the vertical-input voltage; maximum counterclockwise position switches the vertical input directly to the vertical-input deflecting plates.

GAIN/SYNC—potentiometer with two-way switch: clockwise rotation switches either the sweep output or the horizontal-amplifier output (depending upon position of FUNCTION control) to the horizontal-deflecting plates and controls the amplitude of the synchronizing voltage or the horizontal-input voltages; maximum counterclockwise position connects the horizontal input directly to the horizontal-deflecting plates.

RANGE—five-position rotary switch: selects any one of the five time-base ranges; 10-60 cycles, 60-300 cycles, 300-2000 cycles, 2M-10M cycles, or 10M-50M cycles.

FREQUENCY—dual potentiometer: variable control for selecting the exact time-base sweep frequency within each range; lowest frequency, counterclockwise; highest frequency, clockwise.

FUNCTION—four-position rotary switch: selects the type of synchronization desired or the horizontal amplifier, as follows:

- EXT—external sync
- LINE—power-line sync
- INT—internal sync
- HOR—horizontal amplifier

INTENSITY—potentiometer with switch: clockwise rotation turns on the scope power and controls the intensity of the cathode-ray-tube screen pattern; maximum counterclockwise position switches off the power.

FOCUS—potentiometer: variable control for focusing the cathode-ray beam (adjusting for sharpest line).

PRELIMINARY ADJUSTMENT OF JUNIOR SCOPE

Place the PHILCO JUNIOR SCOPE on the bench, and pull out the light shield to its limit; the light shield is the metal cylinder, with the rolled edge surrounding the face of the cathode-ray tube. Before placing the JUNIOR SCOPE in service, make the following adjustments:

1. Turn GAIN/SYNC control clockwise about one-third of its range. Turn the FUNCTION switch to any position except HOR. Turn the INTENSITY control to the extreme counter-

clockwise position until a click of the switch is heard. Turn the FOCUS control midway.

2. Connect the power-supply plug to a 110-120 volt, 60-cycle, a-c source.
3. Turn on the power by turning the INTENSITY control clockwise until a click of the switch is heard. After wait-about one minute for the tubes to warm up, advance the control until a horizontal line appears on the screen.

NOTE

Operating the scope with the line unnecessarily intense will shorten the life of the fluorescent screen material; use only sufficient intensity to provide clear-cut wave forms.

4. Adjust the FOCUS control for maximum sharpness of the line.
 5. Readjust both INTENSITY and FOCUS controls for the desired brilliance and sharpness of line.
- The JUNIOR SCOPE is now ready for use.

MAKING A CALIBRATED SCREEN

In order to make comparisons of the amplitudes of various wave forms observed on the screen without measuring each wave form separately, it is convenient to employ a transparent screen, marked with x and y ordinates, which may be affixed to the face of the cathode-ray tube. Such a screen may be made by using a scribe to scratch the lines on a disc of mica or celluloid; a suggested pattern for the screen is illustrated in figure 3. The disc may be attached to the face of the cathode-ray tube with a few drops of rubber cement.

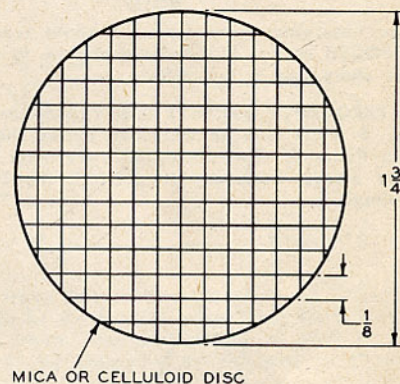

Figure 3.

OPERATING NOTES

VERTICAL INPUT, AND SWEEP FREQUENCY (TIME BASE)

The wave form of an alternating voltage is observed by connecting the test leads to the VERTICAL input jacks and to the source of the voltage to be observed, then setting the RANGE and FREQUENCY controls to obtain a horizontal-sweep frequency which is some multiple of the frequency of the input voltage. The black test lead should be connected to the side of the voltage source nearest ground potential; for B minus connection to an a-c radio, connect this lead to the chassis; for a similar connection on an ac/dc radio, connect to the common connector-bus (one side of the a-c line).

In order to make the wave form stationary, the time-base oscillator which produces the sweeps must be locked in, or synchronized, with the input voltage, by selecting the proper source of sync voltage and adjusting its amplitude correctly.

SYNCHRONIZATION

The sync source is selected by setting the FUNCTION control to EXT, LINE or INT position. If the frequency of the vertical-input voltage is equal to a multiple of the power-line frequency (60 cycles), the FUNCTION control is set to LINE. If the frequency of the input voltage has no common relationship to the line frequency, INT position (internal sync) may be used. If the vertical-input voltage is of very low amplitude, and does not have a sharp-rising wave form, the FUNCTION switch should be set at EXT (external sync), and the HOR/SYNC terminals connected to some point in the source circuit which supplies a larger sync-input voltage.

SYNC AMPLITUDE

The amplitude of sync voltage is controlled by the GAIN/SYNC control. This control should be adjusted by starting it at minimum, and advancing until the screen wave form is suitably stable.

NOTE

Always use the minimum sync amplitude required, since excessive sync voltage will distort the reproduced wave form.

EXPERIMENTAL WAVE FORMS

To observe the manner in which the controls should be adjusted, it is suggested that the user start by observing the wave form of the 60-cycle line voltage. Connect the vertical-input terminals to a power outlet. Set the GAIN/SYNC control about one-third on. Set the FUNCTION control to LINE. Set the RANGE control to 10-60. Adjust the GAIN control until the pattern observed is about half the height of the screen (probably a moving array of curves will be seen). Since the brilliance of the lines decreases with height, the INTENSITY control may now be advanced to obtain the desired brilliance.

Slowly advance the FREQUENCY control toward the high-frequency end (position 10); this adjustment increases the frequency of the time-base oscillator which develops the horizontal sweeps. At some point near 10, the moving pattern will become stationary, and the wave form produced by one cycle of the input voltage may be observed, as shown by the illustration of figure 4. The one-cycle wave form always appears when the sweep frequency is equal to the frequency of the input voltage.

NOTE

When observing wave forms, a slight readjustment of the FOCUS control is usually desirable, to obtain maximum sharpness of the picture.

If the FREQUENCY control is now varied about the middle of its range, a wave form showing two cycles should be seen, as shown in figure 5. The two-cycle wave form always appears when the sweep frequency is one-half the frequency of the input voltage.

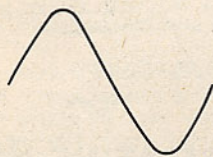

Figure 4.

NOTE

The sync voltage should be readjusted whenever any extensive change is made in the frequency or amplitude of the wave form, or the frequency of the horizontal sweeps.

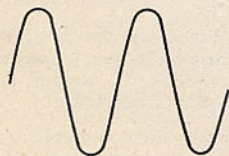

Figure 5.

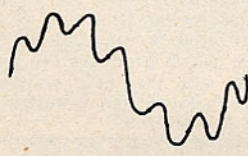

Figure 6.

COMPOSITE WAVE FORMS

In testing some circuits, it may be noted that the desired voltage is modulated by a voltage of another frequency, producing a composite wave form. Figure 6 shows an example of this effect, where a 60-cycle curve is modulated by a 400-cycle signal. Interpretation of the frequencies involved in such wave forms can be made by adjusting the RANGE and FREQUENCY controls for

a one-cycle picture of each voltage, in turn; the frequency of each voltage can be estimated from the settings of these controls. Another method is to check a given wave form against the output of an audio-signal generator, adjusting the generator for a one-cycle wave form; the unknown frequency is then indicated by the dial of the generator.

A-C VOLTAGE MEASUREMENT

A-C voltage can be measured by applying the voltage to the vertical-input terminals of the scope, with the FUNCTION control turned to HOR.

The vertical trace viewed on the screen is the result of the peak-to-peak swing of the input voltage, or 2.82 times the r.m.s. value (r.m.s. value is indicated by the average a-c voltmeter).

The length of the vertical line is converted to r.m.s. values of voltage as follows: with direct connection to the vertical plates, a 30-volt r.m.s. input produces approximately one inch of deflection; with the vertical amplifier in the circuit, and the GAIN control at maximum, one-volt r.m.s. input produces approximately one inch of deflection.

PRACTICAL APPLICATIONS

There are so many applications for the PHILCO JUNIOR SCOPE that it would be impossible to touch upon all of the possibilities in a manual of this nature. However, it is the purpose of this manual to present a number of practical applications for radio service work, so that the user will be able to utilize the methods as stepping stones for the development of special tests of his own as the need arises.

SIGNAL-GENERATOR REQUIREMENTS

Many of the practical applications of the oscilloscope require that a test signal be supplied to the circuits under observation.

The audio-signal generator used should have an output wave form approximating a sine curve; this is desirable to make distortion easy to detect. If the generator at hand does not put out an ideal wave form, it can still be used for distortion analysis by comparing the wave form at the output of the generator with those obtained from the circuits under test; the curves should be practically identical for an amplifier of good characteristics.

The r-f signal generator should be provided with audio modulation of similar characteristics to those described above.

For the alignment of FM radios, or AM circuits having flat-top response, by means of the scope, an FM signal generator is required. This generator should have a suitable deviation range and frequency coverage for the r-f and i-f stages of the radio to be aligned.

MEASURING AUDIO-STAGE GAIN

The JUNIOR SCOPE is used as described under A-C VOLTAGE MEASUREMENT for measuring the gain of an audio stage or tube. Feed a 400-cycle signal to the input stage of the audio amplifier. Connect the vertical-input leads to the output circuit of the stage under test. Adjust the GAIN control until the vertical line nearly fills the screen. Then take the voltage amplitude at the input of the stage. The ratio between the two amplitudes (indicated by the comparative lengths of the lines) represents the voltage gain of the stage.

Many service troubles can be diagnosed by using gain measurements in conjunction with the usual test methods. Among other things, a dynamic test of the tubes is provided. The amount of gain to be expected from a given stage may be estimated after some experience in making such measurements. In many cases, the amplification factor of the tube will serve as a guide.

ISOLATING A DEFECTIVE AUDIO STAGE

A defective audio stage may be located by observing the amplitude and character of an audio signal at various circuits in the amplifier system. Apply a 400-cycle signal to the amplifier and set the controls of the scope to obtain a one-cycle or two-cycle wave form at the generator output; internal sync may be used. Check the signal at each successive grid and plate circuit, observing the comparative amplitudes, presence or absence of hum (60-cycle or 120-cycle voltages), etc. These tests will indicate abnormal operation caused by defective tubes, resistors, condensers, and transformers. If improperly-shaped wave forms appear, refer to the following tests for distortion.

CHECKING FOR DISTORTION

The presence of distortion in the r-f and i-f system can be detected by applying a modulated r-f signal to the aerial circuit, and observing any irregularities in the wave form of the audio signal at the second-detector output circuit or first audio stage. Adjust the r-f signal to the level at which distortion from broadcast reception is noted—this level may be checked quite accurately by observing the a-v-c voltage. If trouble is suspected in i-f stages, an i-f signal of the level required to produce the distortion should be applied to each stage in turn, working from the last stage toward the aerial. Misalignment is a common cause of distortion; if this condition exists, the wave form will indicate the greatest distortion with the signal applied to the aerial circuit.

Most cases of distortion in radios occur in the audio system. For checking distortion in the audio system, apply an audio signal to the input circuit of the audio amplifier, and observe the wave form at the output of each stage in turn until the distortion appears. The test signal used should be at a frequency near that of the tones which appear to produce the distortion. The tone control should be set for maximum treble response. Figure 7 shows a distorted wave form obtained from a resistance-coupled audio stage. The flat-topped peaks indicate saturation (inability to handle normal signal level). Figure 8 shows a distorted wave form obtained at the plate of an output stage.

The ability of the amplifier to handle various frequencies may be checked by observing the wave forms at a number of frequencies; make sure that the input signal is of the same amplitude at each frequency tested; also provide a suitable baffle for the speaker.



Figure 7.

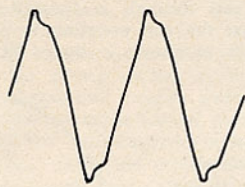

Figure 8.

NOTE

An accurate test of amplifier frequency response is made with the voice coil replaced by a resistor whose value is equivalent to the impedance of the voice coil.

TESTING PUSH-PULL AUDIO STAGES

The PHILCO JUNIOR SCOPE is useful for testing the condition of balance in a push-pull stage. Use the setup described for audio distortion checks, applying a moderate signal level. Check the signal amplitudes at the plates of the push-pull tubes. If there is any appreciable difference in amplitude, check the signals at the two grids. If the same ratio of unbalance does not exist here, the trouble is in the push-pull stage, and all components and tubes should be checked. If the same (or greater) ratio of unbalance does exist at the grids, the trouble is undoubtedly in the phase inverter or driver stage.

CHECKING POWER-SUPPLY RIPPLE (HUM)

One of the major factors indicating the quality of the power supply in a radio is the amount of ripple present in its output voltage. The wave form of the ripple voltage may be observed on the scope, and its amplitude may be used as a measure of the output quality. Defects in filter condensers, power transformers, chokes and other components may be indicated by excessive ripple. The effects produced by substituting any component may be closely observed; also, the ripple voltage of one power supply may be compared with that of another.

Connect the output of the power supply to the vertical input of the scope. If the power supply operates from a 60-cycle source, take the sync voltage from the line. For a vibrator-type power supply, use external sync voltage, taken from one of the plates of the rectifier tube. Adjust the sweep frequency to obtain one or two cycles of ripple wave form on the screen. It will probably be necessary to use maximum vertical gain. An example of ripple wave form is shown in figure 9.

To check the wave form at the input filter condenser, apply the voltage directly to the vertical plates. A typical wave form taken at the input filter condenser of an a-c power supply is shown in figure 10.



Figure 9.



Figure 10.

CHECKING VIBRATOR-TYPE POWER SUPPLIES

The action of the vibrator in an auto-radio power supply can be thoroughly analyzed by observing the alternating-voltage wave form at the plates of the rectifier tube. The conditions that may be identified include: approximate frequency of vibrator operation; condition of buffer condenser (open, too small, or too large) uniformity of operation of the contacts; condition of contacts.

The radio should be placed in operation, with the volume control turned to minimum. Connect the vertical-input leads of the JUNIOR SCOPE to the plates of the rectifier tube. Use internal sync, and adjust the sweep frequency for a one-cycle wave form. The frequency of vibrator operation can then be checked by shifting the vertical-input leads to the output of an audio-signal generator, setting the generator for a one-cycle wave form, and reading the frequency indicated by the generator dial; 115 c.p.s. is the most common frequency used in present-day radios.

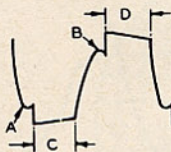

Figure 11.



Figure 12.

Observe the wave form shown in figure 11. The hook-like curves, A and B, on the leading edges, indicate that the buffer condenser is too small. The contact time for each set of points may be compared by observing the flat portions C and D on the curve.

Figure 12 shows a wave form produced by the same vibrator with the correct size of buffer condenser. This curve is a good example of the ideal wave form for vibrator-controlled output. Figure 13 shows the output wave form resulting from defective vibrator contacts; the irregularities indicated at A and B show the effects of the poor contact made on each half of the cycle.



Figure 13.

ALIGNMENT

The PHILCO JUNIOR SCOPE is indispensable for making alignments, or observing the condition of alignment, in radios having i-f amplifiers designed for "flat-top" response. All FM circuits, and certain AM circuits, fall in this class.

AM Circuits

When the i-f transformers are designed for single-peak selectivity, the alignment may be made satisfactorily by means of an ordinary amplitude-modulated r-f signal generator and an output meter.

When the i-f transformers are overcoupled for flat-top response characteristics, an FM signal generator and scope may be used.

To observe the response of the i-f amplifier, the a-v-c circuit should first be disabled. Connect the generator output to the

grid circuit of the converter tube. Set the generator for the center frequency of the i-f amplifier. Connect the vertical input of the scope to the second-detector output, or first-audio circuit. Set the FUNCTION control for external sync, and apply the sync voltage from the generator to the sync-input terminals of the scope.



Figure 14.



Figure 15.

Adjust the horizontal-sweep frequency to the modulating frequency of the generator. Set the deviation just great enough to provide suitable spread of the response curve.

The theoretically ideal response curve (from the standpoint of selectivity) for standard broadcast reception would appear as shown in figure 14, where the top of the curve would represent a width of 10 kc, and the sides would cut off sharply. While such a curve is impossible to obtain, the alignment should be made for the closest approach to this curve. In general, the circuits should be adjusted for the maximum amplitude consistent with the nearest approach to a flat-topped curve. A typical response curve of a correctly-adjusted amplifier is shown in figure 15. The curves shown in figure 16 indicate that certain adjustments are incorrect.



Figure 16.

FM Circuits

For FM alignments, the FM generator must be capable of delivering output at the higher intermediate frequencies used, with a deviation of about 75 kc.

For FM i-f circuits where a limiter is used, the signal voltage developed across the limiter resistor is applied to the vertical-input terminals of the scope; the sync voltage is taken from the FM generator. The response curve obtained for correct alignment is similar to that of figure 15, but much broader, because of the wide pass band.

For radios using the advanced FM detector or the ratio detector, an i-f response curve of the usual type cannot be obtained without the use of an AM detector in conjunction with the scope. However, this is not necessary, for the alignment can be made by observing the effect of the i-f signal on the response curve of the FM detector, which readily shows the effects of non-uniform i-f response. The vertical input is taken from the output of the FM detector. The sync voltage is taken from the FM generator. An output meter is connected to the audio-output stage or speaker voice coil. The response curve for correct alignment is similar to that shown in figure 17 (the direction of the slope depends upon the phase relationship between the vertical-input voltage and the sync voltage). Alignment is made for maximum output, as indicated by the output meter, and maximum linearity of the response curve (particularly the central portion).

It is suggested that the alignment of FM circuits be made as directed in the alignment procedure given for the particular radio; as the alignment progresses, the results may be checked by observation of the detector output wave form, as described above.

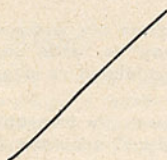

Figure 17.

AMATEUR RADIO APPLICATIONS

NEUTRALIZING TRANSMITTER STAGES

For amateur radio operators and experimenters, the JUNIOR SCOPE is a sensitive indicator when used for neutralizing buffer or final-amplifier stages. Set the FUNCTION switch to HOR. Turn the GAIN control counterclockwise until the switch clicks, thus connecting the vertical-input terminals directly to the deflecting plates. Remove the plate voltage from the stage to be neutralized. Connect the vertical-input terminals to a coil having a few turns of wire, and couple this coil to the "cold" end of the tank coil. Adjust the coupling until the r-f pickup is sufficient to develop a vertical line on the screen. Retune the plate tank condenser for maximum height of this line. Adjust the neutralizing condenser for minimum height of the line. Repeat until no further improvement can be obtained.

CHECKING MODULATION PERCENTAGE

The JUNIOR SCOPE provides an excellent indicator for checking the modulation percentage of amateur phone transmitters. The tests should be made with the transmitter fully loaded, as for normal operation. The two commonly-used modulation indications are the modulated-wave envelope and the trapezoidal pattern.

Modulated-Wave Envelope

Turn the GAIN control counterclockwise until the switch clicks, thus connecting the vertical-input terminals directly to the deflecting plates. Turn the FUNCTION control to INT. Couple a pickup coil of a few turns to the amplifier tank coil, and connect the coil through a twisted-pair line to the vertical terminals. Adjust the coil coupling to obtain a carrier pattern of moderate height, as shown in figure 18. When the transmitter is modulated

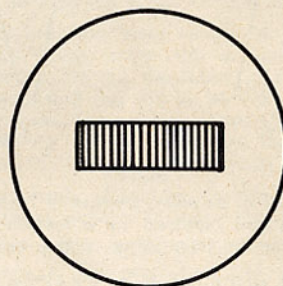

Figure 18.

by voice, a rapidly varying pattern is obtained. When the maximum height of the pattern is twice that of the carrier alone, (figure 19) the modulation is 100%. Overmodulation is characterized by peaks in excess of the 100% modulation amplitude, together with separation of the pattern, as shown in figure 20.

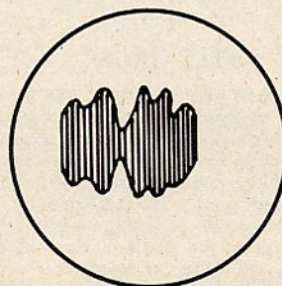

Figure 19.

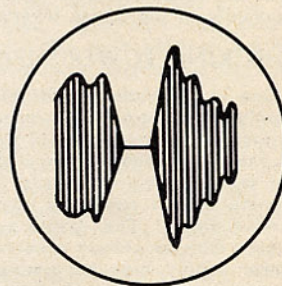

Figure 20.

Trapezoid

Connect the vertical plates as directed in the modulated-envelope presentation. Turn the FUNCTION switch to HOR. Make an audio-voltage divider consisting of a .1-mf fixed condenser, a fixed resistor, and a potentiometer, and connect these across the output of the modulation transformer, as shown in figure 21. Connect the HOR/SYNC red terminal to the potentiometer arm, and the black terminal to ground on the transmitter. The .1-mf

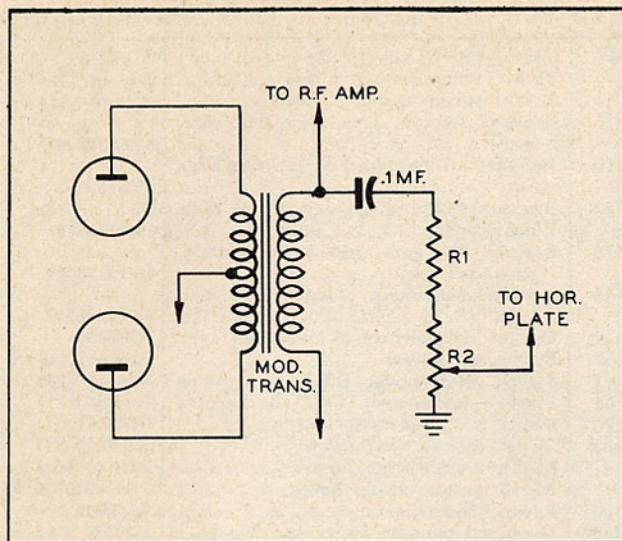

Figure 21.

condenser should be capable of withstanding the modulation peaks. The potentiometer R_2 should be .25 megohm. The resistance value of R_1 may be determined by experiment, and should permit holding the horizontal sweep of the trapezoid well within the screen area; a value of 1 megohm is usually satisfactory. Adjust the r-f pickup loop to obtain moderate height of the vertical line indicating carrier amplitude. See figure 22. Whistling or singing into the mike, using sustained tones, causes the wedge shaped pattern to appear. The higher the percentage of

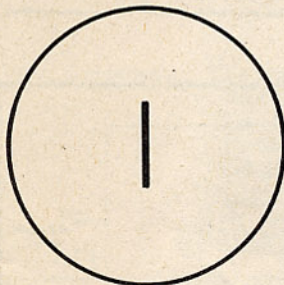

Figure 22.

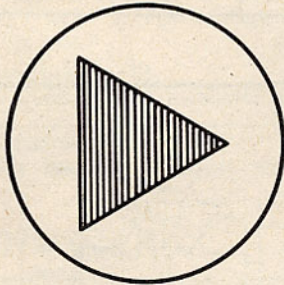

Figure 23.

modulation, the wider and more pointed is the wedge. At 100% modulation, one side of the trapezoid comes to a point, and the other side is twice the height of the carrier alone, as shown in figure 23. Overmodulation is characterized by excessive height, shortening of the trapezoid, and the presence of a "tail," as shown in figure 24.

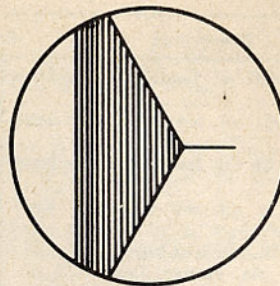

Figure 24.

SERVICING TELEVISION RECEIVERS

The PHILCO JUNIOR SCOPE can be used for the servicing of television receivers. Although certain types of wave forms obtained on the JUNIOR SCOPE show the frequency-response limitations common to instruments of the same general class, it will be found that the characteristic wave forms obtained with this scope from properly operating circuits will serve as a useful guide in locating many troubles causing variations of these wave forms.

The scope can be used to show the presence or absence of signals in the audio and video-amplifier stages. Sweep wave forms can be observed at the output of the saw-tooth generator, and traced through the circuits where they should normally appear. The output of the sync separator can be observed. The effectiveness of power-filter circuits may be checked. Ripple or hum can be traced to its source.

Alignment of the i-f stages can be made by using the scope in conjunction with an FM generator having a suitable deviation range and a sync output.

Since the subject of television servicing is far too complex to be covered in a manual of this size, it is suggested that the serviceman be guided by specific information supplied for those models requiring his attention.

TUBE REPLACEMENT

Access to the tubes and other components in the JUNIOR SCOPE may be had by removing the screws on the side plates and taking off the plates.

The cathode-ray tube may be removed after removing the light shield, which is released by turning it to the left, and pulling straight out. The life of the cathode-ray tube is generally determined by the deterioration of the fluorescent screen. The approach to the limit of its useful life is indicated by inability to obtain satisfactory focus, and by the screen becoming streaky and spotted.

The 6AU6, 6J6, and 6X4 tubes may be checked in a tube tester to determine their condition.

REPLACEMENT PARTS LIST

NOTE: Parts marked with an asterisk (*) are general replacement items, and the numbers may not be identical with those on factory assemblies; also, the electrical values of some replacement items furnished may differ from the values indicated in the schematic and parts list. The values substituted in any case are so chosen that the operation of the instrument will be either unchanged or improved. When ordering replacements, use only the "Service Part No." in this parts list.

Symbol	Description	Service Part No.	Symbol	Description	Service Part No.
C100	Condenser, .1 mf, d-c blocking, vert. input	45-3500-8*	C105	Condenser, .05 mf, control-grid by-pass, C.R.T.	61-0122*
C101	Condenser, .25 mf, screen by-pass, vert. amp.	61-0125*	C106	Condenser, .1 mf, output coupling, hor/sync	45-3500-8*
C102	Condenser, electrolytic, 8 mf, first power filter	45-3002*	C107	Condenser, .25 mf, feedback, time-base osc.	61-0125*
C103	Condenser, electrolytic, 8 mf, second power filter	45-3002*	C108	Condenser, 82 mmf, feedback, time-base osc.	60-00825307*
C104	Condenser, .1 mf, output coupling, vert. amp.	45-3500-8*	C109	Condenser, 390 mmf, feedback, time-base osc.	60-10395407*

REPLACEMENT PARTS LIST (Continued)

Symbol	Description	Service Part No.	Symbol	Description	Service Part No.
C110	Condenser, .002 mf, feedback, time-base osc.	61-0062*	R114	Control (dual unit), frequency	AD-2078
C111	Condenser, .01 mf, feedback, time-base osc.	61-0120*	R114A	potentiometer, 1 meg	Part of R114
C112	Condenser, .05 mf, feedback, time-base osc.	61-0122*	R114B	potentiometer, 1 meg	Part of R114
C113	Condenser, .1 mf, d-c blocking, hor/sync input	45-3500-8*	R115	Resistor, 100,000 ohms, plate load, hor. amp.	66-4103340*
J100	Jack (red), pin, vertical input	AD-2073	R116	Resistor, 1.5 meg, grid circuit, time-base osc.	66-5153340*
J101	Jack (black), pin, vertical input	AD-2074	R117	Resistor, 39,000 ohms, grid circuit, time-base osc.	66-3393340*
J102	Jack (red), pin, hor/sync input	AD-2073	R118	Resistor, 270 ohms, grid-current limiting, time-base osc.	66-1273340*
J103	Jack (black), pin, hor/sync input	AD-2074	R119	Resistor, 680 ohms, cathode bias, hor. amp.	66-1683340*
L100	Coil, 19.5 mh, peaking	AD-2075	R120	Control (with switch), .5 meg, gain/sync	AD-2076
R100	Control (with switch), .5 meg, vertical gain	AD-2076	S100	Switch, a-c power	Part of R106
R101	Resistor, 680 ohms, cathode bias, vert. amp.	66-1683340*	S101	Switch, change-over, C.R.T. vert. plates	Part of R100
R102	Resistor, 220,000 ohms, screen drop., vert. amp.	66-4223340*	S102	Switch, change-over, C.R.T. hor. plates	Part of R120
R103	Resistor, 47,000 ohms, plate load, vert. amp.	66-3473340*	S103	Switch (single-section), function	AD-2081
R104	Resistor, 560 ohms, sync-signal isolating	66-1563340*	S104	Switch (two-section), range	AD-2080
R105	Resistor, 4700 ohms, power-voltage divider	66-2474340*	S104A	switch wafer, top	Part of S104
R106	Control (with switch), .5 meg, intensity	AD-2079	S104B	switch wafer, bottom	Part of S104
R107	Resistor, 47,000 ohms, power-voltage divider	66-3473340*	T100	Power Transformer	AD-2082
R108	Control, 50,000 ohms, focus	AD-2077	W100	Cord and plug assembly, a-c line	L-3339
R109	Resistor, 220,000 ohms, power-voltage divider	66-4223340*	MISCELLANEOUS		
R110	Resistor, 3.3 meg, vert. plate isolating	66-5333340*	Knob, bar pointer	AD-2085	
R111	Resistor, 470,000 ohms, control grid, C.R.T.	66-4473340*	Knob, round (6 req.)	AD-2086	
R112	Resistor, 150,000 ohms, frequency-control circuit	66-4153340*	Leads, test (with pin tips and clips)	AD-2088	
R113	Resistor, 3.3 meg, hor. plate isolating ..	66-5333340*	Plate, model	56-4401	
			Plate, name, PHILCO	76-2114	
			Screw (15 req.) 1/4" self-tapping, slotted-binding-head, housing assembly	1WFA7	
			Screw (4 req.) 1/4-6/32, slotted-round-head, sub-panel mtg.	1WFA7	
			Shield, light	AD-2087	
			Socket, magnal, 11-pin, C.R.T.	AD-2084	
			Socket, (3 req.), miniature, 7-pin	AD-2083	

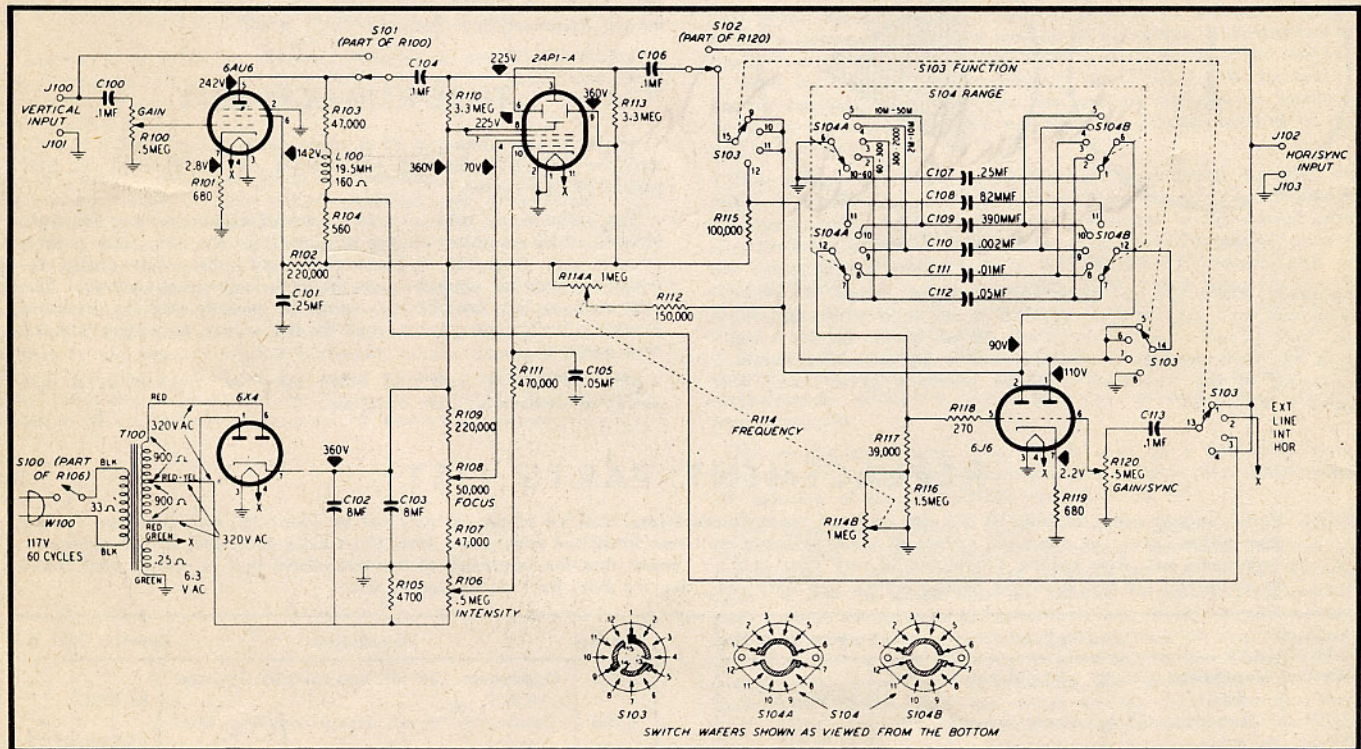

Figure 25. Complete Schematic

ACCESSORY DIVISION

PHILCO CORPORATION

PHILADELPHIA, PA.

Part No. 39-8396

Printed in U. S. A.

PHILCO

Junior Scope



**MODEL
7019**

Small ★ Light ★ Rugged
GENERAL PURPOSE
OSCILLOSCOPE

Only \$66⁰⁰

The Philco Model 7019 Junior Scope fills a need for a practical piece of test equipment in small size and light weight. The Model 7019 is a complete cathode ray oscilloscope with a newly designed cathode ray tube, vertical and horizontal amplifiers, self contained sweep circuit, self contained synchronization and complete power supply.

It is useful for measurement of frequencies up to a hundred kilocycles both vertically and horizontally. With slight loss in gain measurements can be made as high as two hundred kilocycles on both axes. Its applications are practically unlimited and it is especially useful in such fields

as the study of wave shapes, measurements of modulation percentage, peak voltages, phase shift, hum, distortion, adjustment of audio-amplifiers and all radio receiving and transmitting equipment except very high frequency.

A telescoping light shield, which also serves as a magnetic shield for the cathode ray tube, permits use of the equipment even in brightly lighted rooms with a wide angle of vision. The ingenious case design of the Model 7019 permits a great flexibility in the positions in which it can be used. It is versatile enough for on-the-job use or in crowded bench space where a conventional oscilloscope is too large.

CHARACTERISTICS OF THE PHILCO *Junior Scope*

POWER SUPPLY

Input 105-125 volts 50-60 cycles AC
Power consumption 23 watts at 117 volts 60 cycles

OPERATING DATA

	AMPLIFIERS WITH GAIN MAX.	DIRECT CONNECTION TO DEFLECTING PLATES
Vertical Deflection Sensitivity	1 V RMS/inch	30 V RMS/inch
Horizontal Deflection Sensitivity	1 V RMS/inch	24 V RMS/inch
Response, Horizontal and Vertical	-2DB, 20 to 100,000 cycles -6DB, 20 to 200,000 cycles	
Input Resistance5 megohms	.5 megohms
Input Shunt Capacitance	36 MMF	36 MMF
Input Series Capacitance1 MF 600 V	.1 MF 600 V
Polarity of Deflection	Positive direction is up for vertical input and to left for horizontal input.	Positive direction is down for vertical input and to right for horizontal input.
Time Base Oscillator	10 cycles to 50 KC with sweep from left to right	

TUBE COMPLEMENT

6AU6	Vertical Amplifier
6J6	Time Base Oscillator and Horizontal Amplifier
6X4	Power Rectifier
2APIA	Cathode Ray Tube

OVERALL DIMENSION

HEIGHT.....6 3/8 inches WIDTH.....4 inches DEPTH.....10 inches WEIGHT.....5 3/4 lbs.